

# ПНЕВМАТИКА

## ФИТИНГИ



**HYDROCAS**

СЕРВИС ШЛАНГОВ

# СОДЕРЖАНИЕ

## ФИТИНГИ

А СЕРИЯ

3

Р СЕРИЯ

4

В СЕРИЯ

5

С СЕРИЯ

6

D СЕРИЯ

7

ГЛУШИТЕЛИ

8

ТРУБЫ

9

БЫСТРОРАЗЪЕМНЫЕ  
СОЕДИНЕНИЯ

10

ТЕХНИЧЕСКАЯ ИНФОРМАЦИЯ

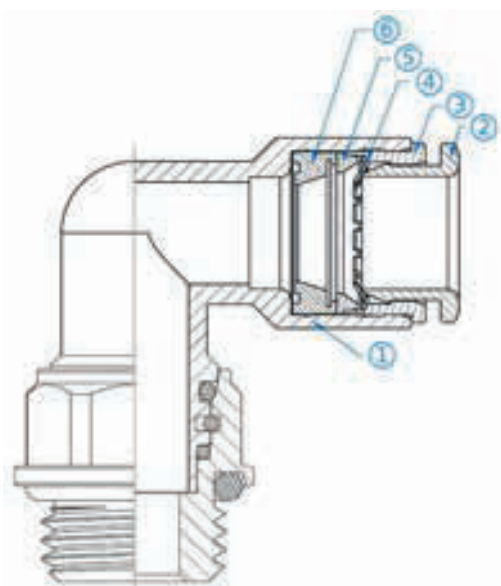

Применение	Сжатый воздух, вода (не питьевая вода)
Рабочее давление	0 ~ 1.5МПа
Диапазон температур	-20 - +80°C
Рекомендуемые трубки	Полиуретан, полиамид, полиэтилен, нейлон
Корпус	Никелированная латунь CW614 N
Отпускающее кольцо	Никелированная латунь CW614 N
Воротник	Никелированная латунь CW614 N
Выступ	Никелированная латунь CW614 N
Уплотнение	<b>NBR</b>

**PF2-010**

Прямое соединение

**PF2-010**

Прямое соединение

Код	B	C	L	CH	Труба	Резьба	Код	B	C	L	CH	Труба	Резьба
PF2010-04-01	9.9	4	22.1	10	4мм.	M5x0.8	PF2010-08-M12	16.7	6.5	25	14	8мм.	M12x1.5
PF2010-04-02	9.9	5.5	19.3	12	4мм.	G1/8	PF2010-09-06	20	7.5	25.9	17	9.52мм.	G3/8
PF2010-04-04	9.9	6.5	18.7	17	4мм.	G1/4	PF2010-10-04	16.9	6.5	29.7	17	10мм.	G1/4
PF2010-06-01	11.9	4	22.3	12	6мм.	M5x0.8	PF2010-10-06	20	7.5	25.9	17	10мм.	G3/8
PF2010-06-02	11.9	5.5	20	12	6мм.	G1/8	PF2010-10-08	16.9	10	26.5	24	10мм.	G1/2
PF2010-06-04	11.9	6.5	21.3	17	6мм.	G1/4	PF2010-12-04	19.9	6.5	32.2	20	12мм.	G1/4
PF2010-06-M12	16.7	6.5	22.4	14	6мм.	M12x1.5	PF2010-12-06	19.9	7.5	30	20	12мм.	G3/8
PF2010-07-04	16	6.5	21	12	6.35мм.	G1/4	PF2010-12-08	19.9	10	31	24	12мм.	G1/2
PF2010-08-02	13.9	5.5	25.5	13.9	8мм.	G1/8	PF2010-13-08	20	7.5	30	20	12.7мм.	G1/2
PF2010-08-04	13.9	6.5	23.6	13.9	8мм.	G1/4	PF2010-14-06	21.8	7.5	32.5	22	14мм.	G3/8
PF2010-08-06	13.9	7.5	22.6	20	8мм.	G3/8	PF2010-14-08	21.8	10	30.5	24	14мм.	G1/2

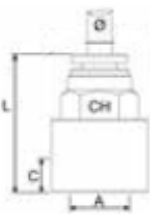
**PF2-020**

Прямое  
соединение

Код	C	L	CH	Труба	Резьба
-----	---	---	----	-------	--------

PF2020-04-02	8	24.8	12	4мм.	G1/8
PF2020-04-04	11	27.8	17	4мм.	G1/4
PF2020-06-02	8	25	12	6мм.	G1/8
PF2020-06-04	11	28	17	6мм.	G1/4
PF2020-08-02	8	27.1	14	8мм.	G1/8
PF2020-08-04	11	30	17	8мм.	G1/4
PF2020-10-04	11	33.3	17	10мм.	G1/4
PF2020-10-06	12	34.3	20	10мм.	G3/8



**PF2-030**

Прямое  
соединение

Код	A	L	Труба
-----	---	---	-------

PF2030-04-04	8.5	28	4мм.
PF2030-06-06	11.5	35	6мм.
PF2030-07-07	14	33.5	6.35мм.
PF2030-08-08	13.5	41.5	8мм.
PF2030-09-09	20	41.3	9.52мм.
PF2030-10-10	15.5	44.5	10мм.
PF2030-12-12	17.5	47.3	12мм.
PF2030-13-13	22	46.4	12.7мм.
PF2030-14-14	19.5	53.5	14мм.





**PF2-030**

Прямое  
соединение

Код	A	L	Труба 1	Труба 2
-----	---	---	---------	---------

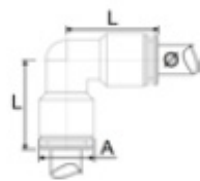
PF2030-06-04	14	33	6мм.	4мм.
PF2030-08-06	16	37.5	8мм.	6мм.
PF2030-10-08	20	41.3	10мм.	8мм.
PF2030-12-10	22	46.4	12мм.	10мм.





**PF2-040**

Угловое  
соединение

Код	A	L	Труба
-----	---	---	-------

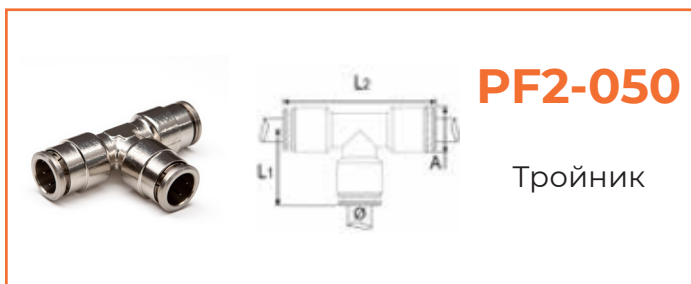
PF2040-04-04	8.5	17	4мм.
PF2040-05-05	12	22.9	5мм.
PF2040-06-06	11.5	22.5	6мм.
PF2040-08-08	13.5	26.5	8мм.
PF2040-10-10	15.5	28	10мм.
PF2040-12-12	17.5	30.8	12мм.
PF2040-14-14	19.5	38.5	14мм.



**PF2-050**

Тройник

Код	A	L1	L2	Труба
-----	---	----	----	-------

PF2050-04-04	8.5	17	34	4мм.
PF2050-05-05	11.5	22.5	45	5мм.
PF2050-06-06	11.5	22.5	45	6мм.
PF2050-08-08	13.5	26.5	53	8мм.
PF2050-10-10	15.5	28	56	10мм.
PF2050-12-12	17.5	30.8	61.6	12мм.
PF2050-14-14	19.5	38.5	77	14мм.



**PF2-070**

Ниппель  
резьбовой

Код	B	L1	L2	CH	Труба	Резьба
-----	---	----	----	----	-------	--------

PF2070-04-01	4	16	24.5	8	4мм.	M5x0.8
PF2070-04-02	5.5	16	27	10	4мм.	G1/8
PF2070-04-04	6.5	16	28	12	4мм.	G1/4
PF2070-05-01	4	15.5	24	8	5мм.	M5x0.8
PF2070-05-02	5.5	15.5	26.5	10	5мм.	G1/8
PF2070-05-04	6.5	14.5	27.5	12	5мм.	G1/4
PF2070-06-01	4	15.5	24	8	6мм.	M5x0.8
PF2070-06-02	5.5	15.5	26.5	10	6мм.	G1/8
PF2070-06-04	6.5	14.5	27.5	12	6мм.	G1/4
PF2070-06-M12	6.5	14.5	27.5	12	6мм.	M12x1.5
PF2070-08-02	5.5	17.5	28.5	12	8мм.	G1/8



**PF2-070**

Ниппель  
резьбовой

Код	B	L1	L2	CH	Труба	Резьба
-----	---	----	----	----	-------	--------

PF2070-08-04	6.5	17.5	30.5	12	8мм.	G1/4
PF2070-08-06	7.5	17.5	31	16	8мм.	G3/8
PF2070-08-M12	6.5	17.5	30.5	12	8мм.	M12x1.5
PF2070-10-04	6.5	20	33	12	10мм.	G1/4
PF2070-10-06	7.5	20	33.5	16	10мм.	G3/8
PF2070-12-04	6.5	22	34	14	12мм.	G1/4
PF2070-12-06	7.5	22	35.5	16	12мм.	G3/8
PF2070-12-08	10	22	37.5	19	12мм.	G1/2
PF2070-14-06	7.5	30	43.5	16	14мм.	G3/8
PF2070-14-08	10	30	45.5	19	14мм.	G1/2



**PF2-090**

Ниппель  
переходной

Код	A	L	Труба 1	Труба 2
-----	---	---	---------	---------

PF2090-04-06	9	35.5	4мм.	6мм.
PF2090-05-04	9	32.8	5мм.	4мм.
PF2090-06-04	8.5	33	6мм.	4мм.
PF2090-06-05	11.5	39.4	6мм.	5мм.
PF2090-06-08	13.5	42.6	6мм.	8мм.
PF2090-08-04	9	33.8	8мм.	4мм.
PF2090-08-05	11.5	37.5	8мм.	5мм.
PF2090-08-06	11.5	37.5	8мм.	6мм.
PF2090-10-06	12	42.6	10мм.	6мм.
PF2090-10-08	13.5	43.7	10мм.	8мм.





**PF2-090**

Ниппель переходной

Код	A	L	Труба 1	Труба 2
-----	---	---	---------	---------

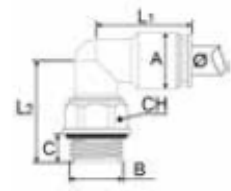
PF2090-12-04	9	38.8	12мм.	4мм.
PF2090-12-06	12	41.4	12мм.	6мм.
PF2090-12-08	14	45.2	12мм.	8мм.
PF2090-12-10	15.5	45.5	12мм.	10мм.
PF2090-14-10	16.5	49.6	14мм.	10мм.
PF2090-14-12	18.5	51.2	14мм.	12мм.





**PF2-110**

Ниппель резьбовой

Код	A	C	L1	L2	CH	Труба	Резьба
-----	---	---	----	----	----	-------	--------

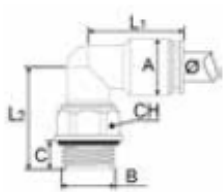
PF2110-04-01	8.5	7.5	17	20.5	10	4мм.	M5x0.8
PF2110-04-02	8.5	5.5	17	21	10	4мм.	G1/8
PF2110-04-04	8.5	6.5	17	22.5	14	4мм.	G1/4
PF2110-05-01	12	5.5	22.9	16.3	10	5мм.	M5x0.8
PF2110-05-02	12	5.5	18.3	22.9	12	5мм.	G1/8
PF2110-05-04	12	6.5	22.9	20.8	14	5мм.	G1/4
PF2110-06-01	11.5	4	22.5	16.5	10	6мм.	M5x0.8
PF2110-06-02	11.5	5.5	22.5	19.5	12	6мм.	G1/8
PF2110-06-04	11.5	6.5	22.5	21	14	6мм.	G1/4
PF2110-08-02	13.5	5.5	26.5	21	14	8мм.	G1/8
PF2110-08-04	13.5	6.5	26.5	23	14	8мм.	G1/4





**PF2-110**

Ниппель резьбовой

Код	A	C	L1	L2	CH	Труба	Резьба
-----	---	---	----	----	----	-------	--------

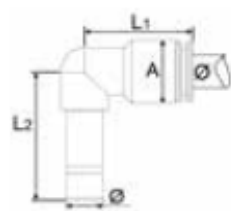
PF2110-08-06	13.5	7.5	26.5	25	16	8мм.	G3/8
PF2110-10-04	15.5	6.5	28	23	14	10мм.	G1/4
PF2110-10-06	15.5	7.5	28	25	16	10мм.	G3/8
PF2110-10-08	15.5	10	28	27.5	19	10мм.	G1/2
PF2110-12-04	17.5	6.5	30.8	24.5	17	12мм.	G1/4
PF2110-12-06	17.5	7.5	30.8	26.5	16	12мм.	G3/8
PF2110-12-08	17.5	10	30.8	29	19	12мм.	G1/2
PF2110-14-06	19.5	7.5	38.5	26.5	16	14мм.	G3/8
PF2110-14-08	19.5	10	38.5	29	19	14мм.	G1/2





**PF2-130**

Ниппель угловой

Код	A	L1	L2	Труба
-----	---	----	----	-------

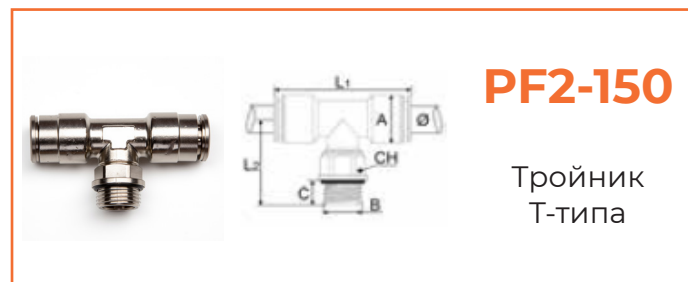
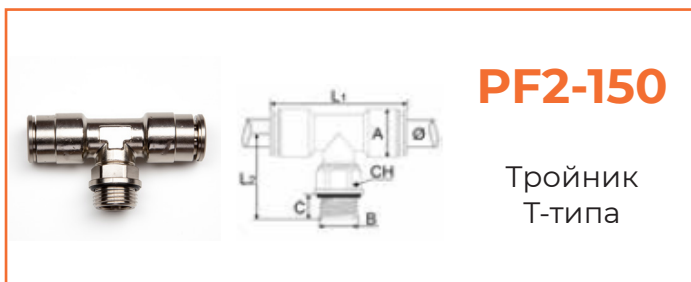
PF2130-04-04	9.9	18.2	34	4мм.
PF2130-06-06	11.9	19	35.2	6мм.
PF2130-08-08	13.9	23	41	8мм.
PF2130-10-10	16.9	27.5	46.7	10мм.
PF2130-12-12	19.9	29.3	50.5	12мм.



Код	A	C	L1	L2	CH	Труба	Резьба
-----	---	---	----	----	----	-------	--------

Код	A	C	L1	L2	CH	Труба	Резьба
-----	---	---	----	----	----	-------	--------

PF2150-04-02	8.5	5.5	34	21	10	4мм.	G1/8
PF2150-04-04	8.5	6.5	34	22.5	14	4мм.	G1/4
PF2150-05-02	12	5.5	45.8	17.8	12	5мм.	G1/8
PF2150-06-02	11.5	5.5	45	19.5	12	6мм.	G1/8
PF2150-06-04	11.5	6.5	45	21	14	6мм.	G1/4
PF2150-08-02	13.5	5.5	53	21	14	8мм.	G1/8
PF2150-08-04	13.5	6.5	53	23	14	8мм.	G1/4

PF2150-08-06	13.5	7.5	53	25	16	8мм.	G3/8
PF2150-10-04	15.5	6.5	56	23	14	10мм.	G1/4
PF2150-10-06	15.5	7.5	56	25	16	10мм.	G3/8
PF2150-12-04	17.5	6.5	61.6	24.5	17	12мм.	G1/4
PF2150-12-06	17.5	7.5	61.6	26.5	16	12мм.	G3/8
PF2150-12-08	17.5	10	61.6	29	19	12мм.	G1/2
PF2150-14-08	19.5	10	77	29	19	14мм.	G1/2

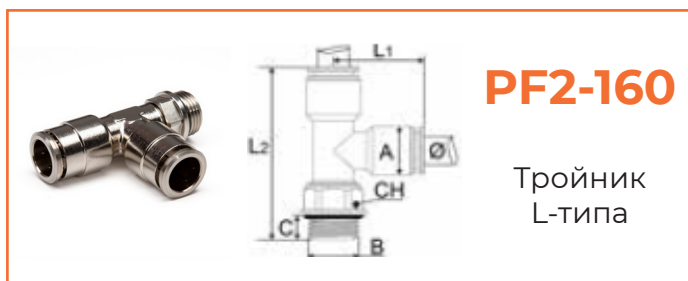
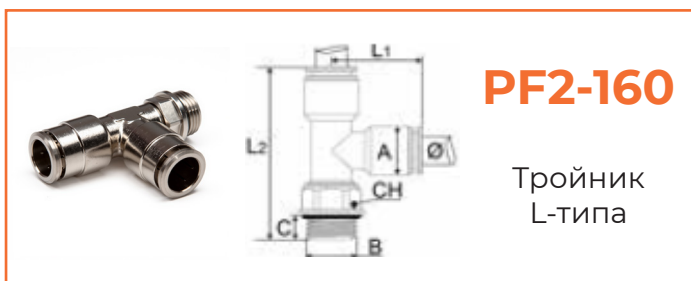

Код	A	C	L1	L2	CH	Труба	Резьба
-----	---	---	----	----	----	-------	--------

Код	A	C	L1	L2	CH	Труба	Резьба
-----	---	---	----	----	----	-------	--------

PF2160-04-01	12	4	22.9	39.2	10	4мм.	M5x0.8
PF2160-04-02	8.5	5.5	21	38	10	4мм.	G1/8
PF2160-06-02	11.5	5.5	22.5	42	12	6мм.	G1/8
PF2160-06-04	11.5	6.5	21	43.5	14	6мм.	G1/4
PF2160-08-02	13.5	5.5	21	47.5	14	8мм.	G1/8
PF2160-08-04	13.5	6.5	23	49.5	14	8мм.	G1/4

PF2160-08-06	13.5	7.5	25	51.5	16	6мм.	G3/8
PF2160-10-04	15.5	6.5	23	51	14	10мм.	G1/4
PF2160-10-06	15.5	7.5	25	53	16	10мм.	G3/8
PF2160-12-04	17.5	6.5	24.5	55.3	17	12мм.	G1/4
PF2160-12-06	17.5	7.5	30.8	57.3	16	12мм.	G3/8
PF2160-12-08	17.5	10	30.8	59.8	19	12мм.	G1/2

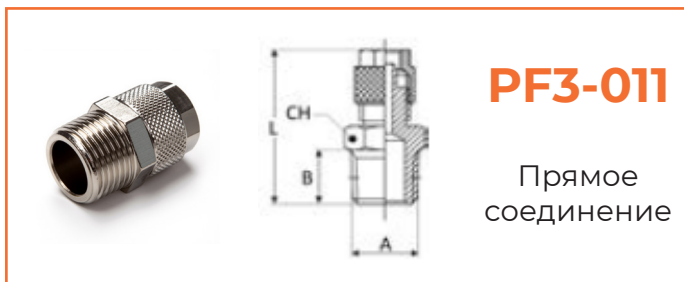

## PF3-011

Прямое  
соединение

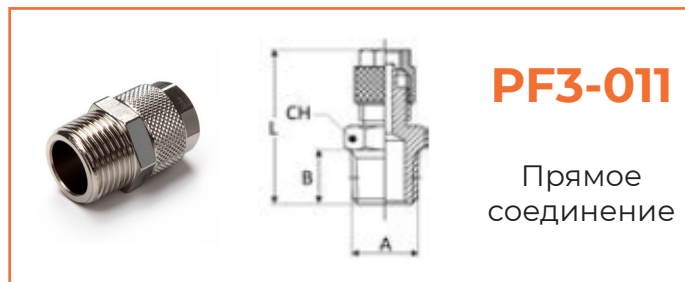

## PF3-011

Прямое  
соединение

Код	B	L	CH	Труба	Резьба
PF3011-04-02	5.5	18	12	4мм.	R1/8
PF3011-05-02	5.5	21.3	12	5мм.	R1/8
PF3011-06-02	7.5	22	8	6мм.	R1/8
PF3011-06-04	9.5	24.5	8	6мм.	R1/4
PF3011-08-02	7.5	25.5	12	8мм.	R1/8
PF3011-08-04	9.5	28	12	8мм.	R1/4
PF3011-08-06	10.5	29.5	12	8мм.	R3/8

Код	B	L	CH	Труба	Резьба
PF3011-10-02	5.5	26.3	14	10мм.	R1/8
PF3011-10-04	9.5	29.5	13	10мм.	R1/4
PF3011-10-06	10.5	21	13	10мм.	R3/8
PF3011-10-08	10	32.2	24	10мм.	R1/2
PF3011-12-06	10.5	29	15	12мм.	R3/8
PF3011-12-08	13.5	32.5	15	12мм.	R1/2
PF3011-15-08	10	35.7	24	15мм.	R1/2

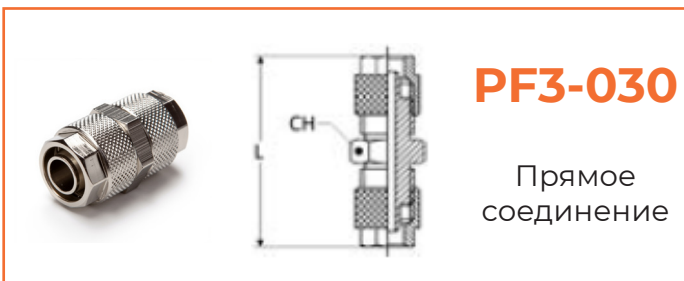

## PF3-030

Прямое  
соединение

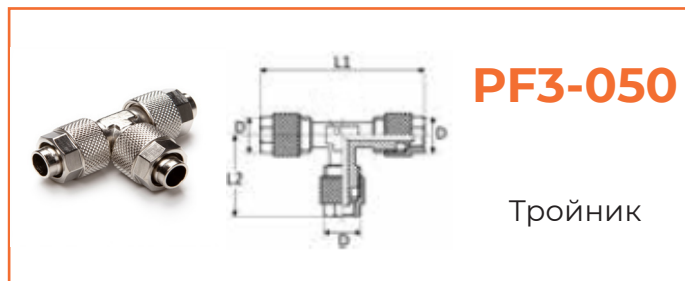

## PF3-050

Тройник

Код	A	L	Труба
PF3030-04-04	20	8	4мм.
PF3030-05-05	25.5	10	5мм.
PF3030-06-06	25.5	8	6мм.
PF3030-08-08	32.5	12	8мм.
PF3030-10-10	36	13	10мм.
PF3030-12-12	32.5	15	12мм.
PF3030-15-15	44	21	15мм.

Код	L1	L2	Труба
PF3050-04-04	34	15	4мм.
PF3050-05-05	32	16	5мм.
PF3050-06-06	33	16.5	6мм.
PF3050-08-08	40	20	8мм.
PF3050-10-10	47	23.5	10мм.
PF3050-12-12	47	23.5	12мм.
PF3050-15-15	66	33	15мм.



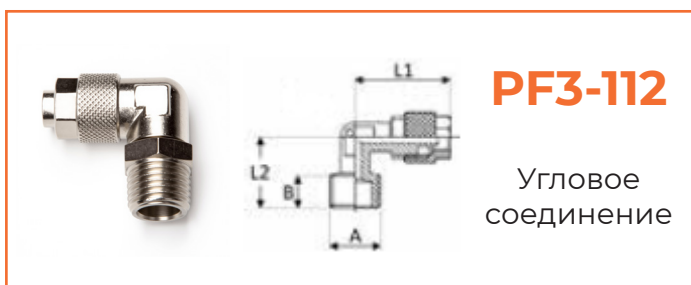

**PF3-112**

Угловое  
соединение

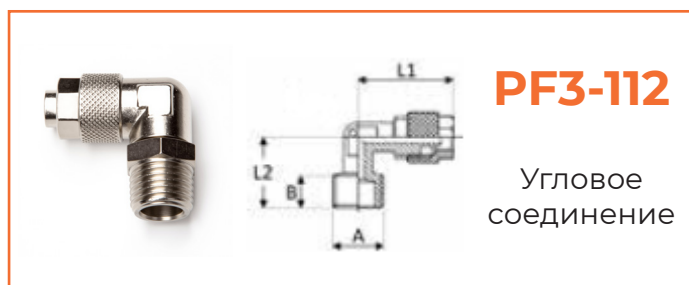

**PF3-112**

Угловое  
соединение

Код	B	L1	L2	Труба	Резьба
-----	---	----	----	-------	--------

Код	B	L1	L2	Труба	Резьба
-----	---	----	----	-------	--------

PF3112-05-02	5	16	13	5мм.	R1/8
PF3112-06-02	7.5	16.5	20.5	6мм.	R1/8
PF3112-06-04	9.5	16.5	23.5	6мм.	R1/4
PF3112-08-02	7.5	20	19	8мм.	R1/8
PF3112-08-04	9.5	20	22	8мм.	R1/4
PF3112-08-06	10.5	20	23	8мм.	R3/8

PF3112-10-04	9.5	23.5	24	10мм.	R1/4
PF3112-10-06	10.5	23.5	25	10мм.	R3/8
PF3112-10-08	13.5	23.5	28.5	10мм.	R1/2
PF3112-12-06	10.5	23.5	25	12мм.	R3/8
PF3112-12-08	13.5	23.5	28.5	12мм.	R1/2
PF3112-15-08	14.5	33	30	15мм.	R1/2

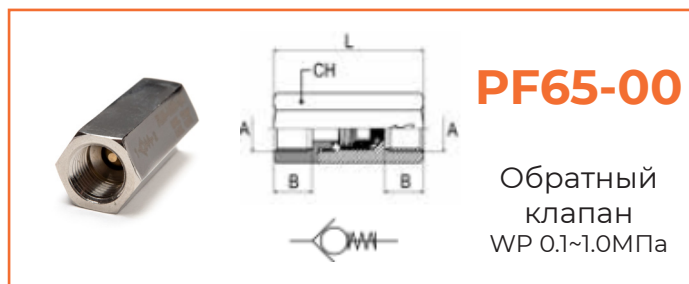

**PF65-00**

Обратный  
клапан  
WP 0.1~1.0МПа

Код	B	L	CH	Резьба
-----	---	---	----	--------

PV65-0000-02-02	10	34	13	G1/8
PV65-0000-04-04	11	43	17	G1/4
PV65-0000-06-06	14	55	23	G3/8
PV65-0000-08-08	14	58.5	27	G1/2

### ТЕХНИЧЕСКАЯ ИНФОРМАЦИЯ

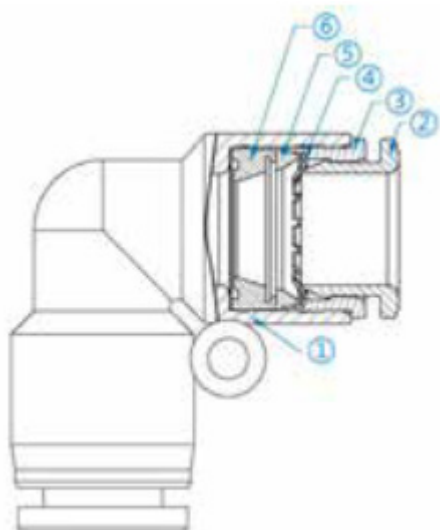

Применение	Сжатый воздух, вода (не питьевая вода)
Рабочее давление	0 - 1.0 МПа
Диапазон температур	0 - +60°C
Рекомендуемые трубки	Полиуретан, полиамид, полиэтилен, нейлон
Корпус	Армированный пластик
Отпускающее кольцо	<b>POM</b>
Воротник	Цинк
Выступ	Нерж. сталь
Опорное кольцо	<b>POM</b>
Уплотнение	<b>NBR</b>

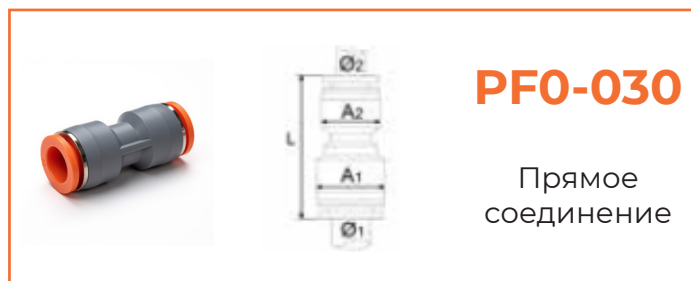
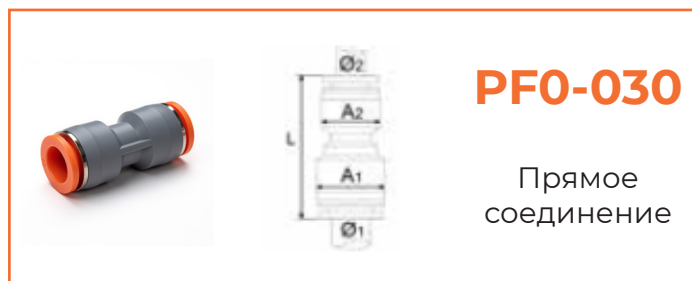

Код	A1	A2	L	Труба 1	Труба 2
-----	----	----	---	---------	---------

Код	A1	A2	L	Труба 1	Труба 2
-----	----	----	---	---------	---------

PF0030-04-04	9.9	9.9	32.8	4мм.	4мм.	PF0030-10-10	16.9	16.9	47.8	10мм.	10мм.
PF0030-06-04	11.9	9.9	34.9	6мм.	4мм.	PF0030-12-08	19.9	13.9	49.4	12мм.	8мм.
PF0030-06-06	11.9	11.9	34.9	6мм.	6мм.	PF0030-12-10	19.9	16.9	49.4	12мм.	10мм.
PF0030-08-06	13.9	11.9	38.4	8мм.	6мм.	PF0030-12-12	19.9	19.9	49.4	12мм.	12мм.
PF0030-08-08	13.9	13.9	38.4	8мм.	8мм.	PF0030-14-14	21.8	21.8	48.3	14мм.	14мм.
PF0030-10-06	16.9	11.9	47.8	10мм.	6мм.	PF0030-16-16	23.8	23.8	48.6	16мм.	16мм.
PF0030-10-08	16.9	13.9	47.8	10мм.	8мм.						



**PF0-040**

Угловое  
соединение

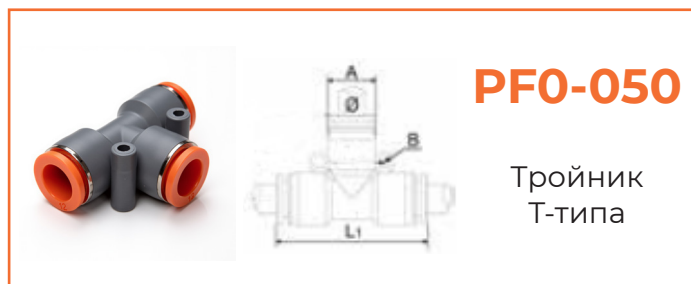

**PF0-050**

Тройник  
Т-типа

Код	A	B	L1	Труба
-----	---	---	----	-------

PF0040-04-04	9.9	3.2	17.25	4мм.
PF0040-06-06	11.9	3.2	19	6мм.
PF0040-08-08	13.9	3.2	22.1	8мм.
PF0040-10-10	16.9	4.2	25.6	10мм.
PF0040-12-12	19.9	4.2	29.6	12мм.

Код	A	B	L1	Труба
-----	---	---	----	-------

PF0050-04-04	9.9	3.2	36.4	4мм.
PF0050-06-06	11.9	3.2	38	6мм.
PF0050-08-08	13.9	3.2	45	8мм.
PF0050-10-10	16.9	4.2	56.2	10мм.
PF0050-12-12	19.9	4.2	59.6	12мм.

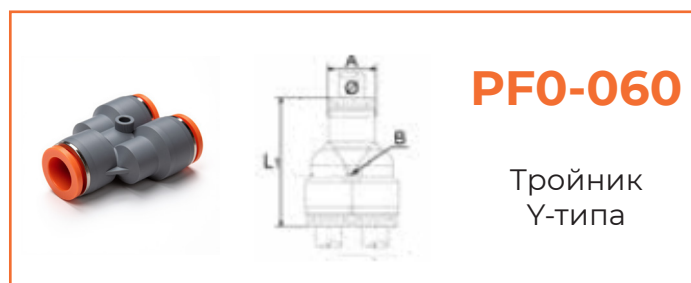

**PF0-060**

Тройник  
Y-типа

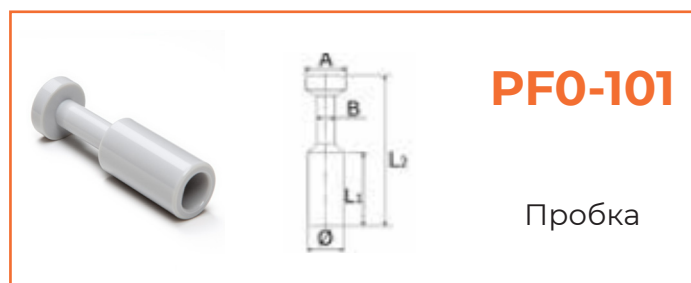

**PF0-101**

Пробка

Код	A	B	L1	Труба
-----	---	---	----	-------

PF0060-04-04	9.9	3.2	35.4	4мм.
PF0060-06-06	11.9	3.2	37.1	6мм.
PF0060-08-08	13.9	3.2	39.5	8мм.
PF0060-10-10	16.9	4.2	49.4	10мм.
PF0060-12-12	19.9	4.2	53.5	12мм.

Код	A	B	L1	L2	Труба
-----	---	---	----	----	-------

PF0101-00-04	5	3	15	28	4мм.
PF0101-00-06	7	3	17	33	6мм.
PF0101-00-08	9	4	18	37	8мм.
PF0101-00-10	11	5	20.5	42	10мм.
PF0101-00-12	13	6	23	44	12мм.

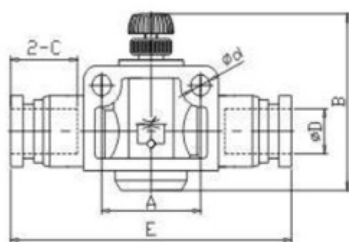

## PV5-300

Микровентиль

Код	ΦD	Φd	A	B min	B max	E	C	X
PV5300-03-04-04	4	3.2	14	27	29.2	39.5	14.4	9.9
PV5300-03-06-06	6	4.3	19.3	38.5	44	46.5	15.5	11.9
PV5300-03-08-08	8	4.3	21.5	42.3	47.8	51.5	16.8	13.9
PV5300-03-10-10	10	4.3	25.9	47.1	51.7	60.8	19.5	16.9

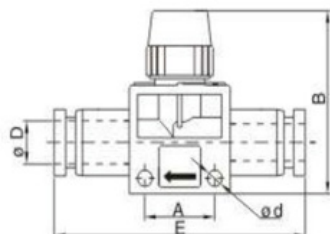

## PV5-500

Минирегулятор

Код	ΦD	Φd	A	B	E	X	X1	C1	C2
PV5500-02-04-04	4	4.2	16.2	40.2	50.3	9.9			
PV5500-02-06-06	6	4.2	16.2	39.9	51.1	12		17.9	17.9
PV5500-02-08-08	8	4.2	16.2	39.9	52	14		18.8	18.8
PV5500-02-10-10	10	4.2	21.2	45	63.3	17		21	21

**ТЕХНИЧЕСКАЯ ИНФОРМАЦИЯ**



Применение	Сжатый воздух, вода (не питьевая вода)
Рабочее давление	2...10 bar
Рабочая температура	+0С...+60С
Материалы корпуса	Аллюминий
Номинальный диаметр	2,5
Номинальный расход	100

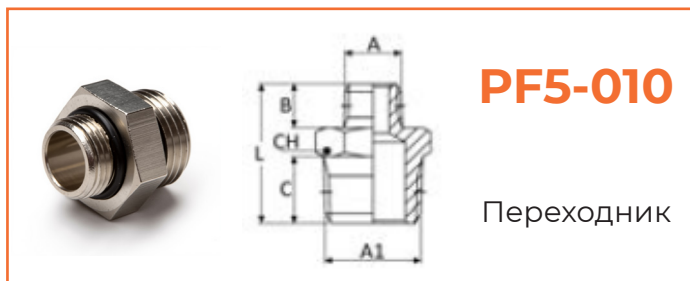
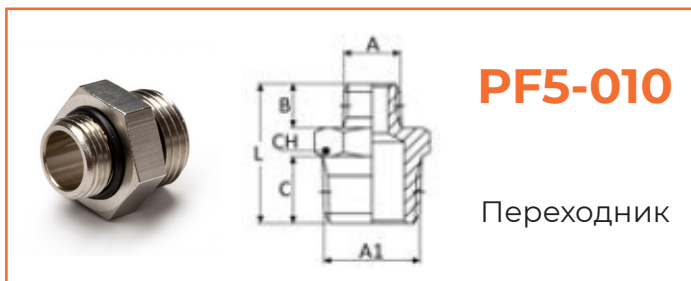

Код	L	B	C	CH	Резьба A	Резьба A1
-----	---	---	---	----	-------------	--------------

Код	L	B	C	CH	Резьба A	Резьба A1
-----	---	---	---	----	-------------	--------------

PF5010-01-02	14.5	4	5.5	12	M5x0.8	G1/8
PF5010-02-02	15.5	5.5	5.5	14	G1/8	G1/8
PF5010-02-04	18	5.5	7.5	17	G1/8	G1/4
PF5010-02-06	19	5.5	7.5	20	G1/8	G3/8
PF5010-04-04	19.5	7.5	7.5	17	G1/4	G1/4
PF5010-04-06	21	7.5	7.5	20	G1/4	G3/8
PF5010-04-08	24.5	7.5	10	24	G1/4	G1/2

PF5010-06-06	21	7.5	7.5	20	G3/8	G3/8
PF5010-06-08	26	7.5	10.5	24	G3/8	G1/2
PF5010-08-08	27.5	10.5	10.5	24	G1/2	G1/2
PF5010-08-12	29	10.5	11.5	32	G1/2	G3/4
PF5010-12-12	30	11.5	11.5	32	G3/4	G3/4
PF5010-12-16	36	11.5	14	36	G3/4	G1
PF5010-16-16	38	14	14	36	G1	G1

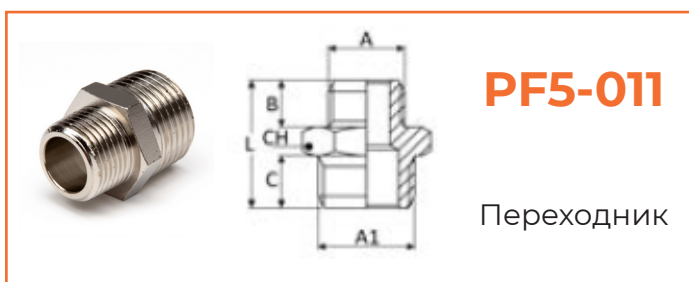

**PF5-011**

Переходник

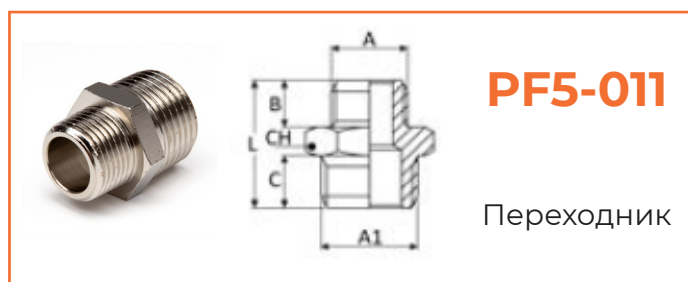

**PF5-011**

Переходник

Код	L	B	C	CH	Резьба A	Резьба A1
PF5011-02-02	19	7.5	7.5	10	R1/8	R1/8
PF5011-02-04	21	7.5	9.5	14	R1/8	R1/4
PF5011-02-06	23	7.5	10.5	17	R1/8	R3/8
PF5011-04-04	23	9.5	9.5	14	R1/4	R1/4
PF5011-04-06	24.5	9.5	10.5	17	R1/4	R3/8
PF5011-04-08	28	9.5	13.5	21	R1/4	R1/2
PF5011-06-06	25.5	10.5	10.5	17	R3/8	R3/8

Код	L	B	C	CH	Резьба A	Резьба A1
PF5011-06-08	29	10.5	13.5	21	R3/8	R1/2
PF5011-08-08	31.5	13.5	13.5	21	R1/2	R1/2
PF5011-08-12	38.5	13.5	18	27	R1/2	R3/4
PF5011-12-12	44	18	18	27	R3/4	R3/4
PF5011-12-16	52	18	22	34	R3/4	R1
PF5011-16-16	56	22	22	34	R1	R1

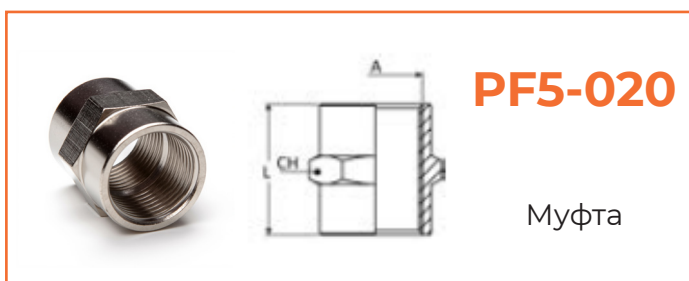

**PF5-020**

Муфта

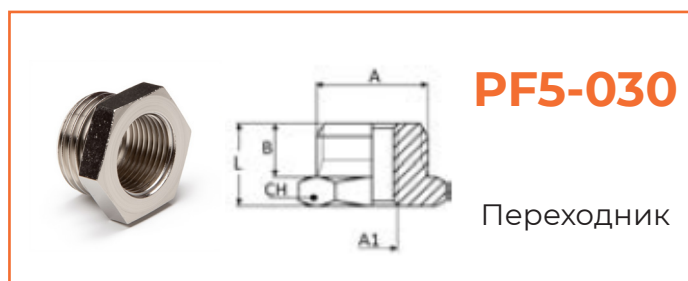

**PF5-030**

Переходник

Код	L	CH	Резьба
PF5020-01-01	14	8	M5x0.8
PF5020-02-02	17	14	G1/8
PF5020-04-04	22	17	G1/4
PF5020-06-06	24	20	G3/8
PF5020-08-08	28	24	G1/2
PF5020-12-12	32	32	G3/4
PF5020-16-16	36	32	G1

Код	B	L	CH	Резьба A	Резьба A1
PF5030-02-01	5.5	9.5	12	G1/8	M5x0.8
PF5030-04-02	7.5	11.5	17	G1/4	G1/8
PF5030-06-02	7.5	12.5	20	G3/8	G1/8
PF5030-06-04	10.5	13	20	G3/8	G1/4
PF5030-08-04	10.5	16	24	G1/2	G1/4
PF5030-08-06	16	16	24	G1/2	G3/8
PF5030-12-08	12	19	32	G3/4	G1/2

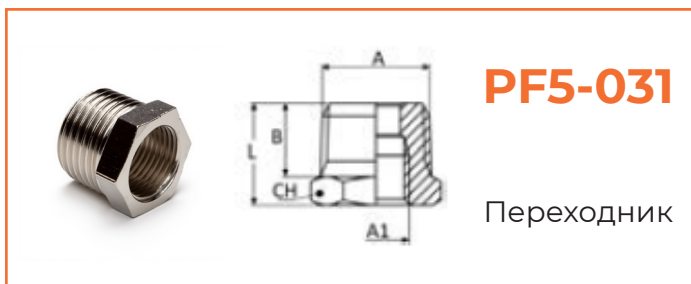

**PF5-031**

Переходник

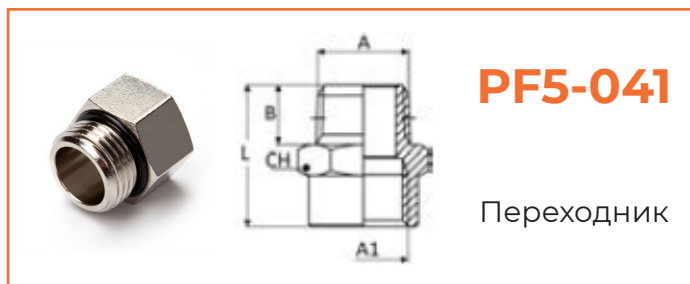

**PF5-041**

Переходник

Код	B	L	CH	Резьба А	Резьба А1
-----	---	---	----	----------	-----------

Код	B	L	CH	Резьба А	Резьба А1
-----	---	---	----	----------	-----------

PF5031-04-02	9.5	13.5	14	R1/4	G1/8
PF5031-06-02	10.5	15	17	R3/8	G1/8
PF5031-06-04	10.5	15	17	R3/8	G1/4
PF5031-08-02	13.5	19.5	21	R1/2	G1/8
PF5031-08-04	13.5	19.5	21	R1/2	G1/4
PF5031-08-06	13.5	19.5	21	R1/2	G3/8
PF5031-12-08	18	25	27	R3/4	G1/2
PF5031-16-08	32	22	34	R1	G1/2

PF5041-02-02	7.5	17.5	8.5	R1/8	G1/8
PF5041-02-04	7.5	20	17	R1/8	G1/4
PF5041-04-04	9.5	22	17	R1/4	G1/4
PF5041-04-06	9.5	23	20	R1/4	G3/8
PF5041-06-06	9.5	23	20	R3/8	G3/8
PF5041-06-08	9.5	26	24	R3/8	G1/2
PF5041-08-08	10.5	27	24	R1/2	G1/2
PF5041-08-12	13.5	31.5	32	R1/2	G3/4

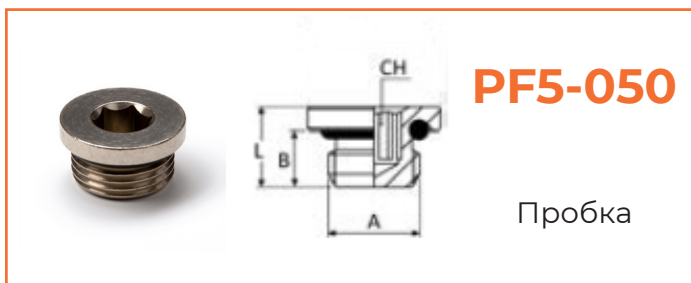

**PF5-050**

Пробка

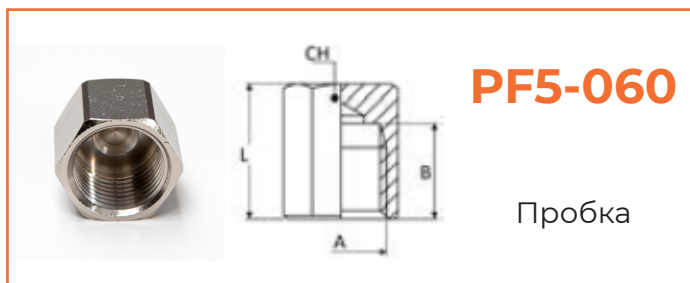

**PF5-060**

Пробка

Код	B	L	CH	Резьба
-----	---	---	----	--------

Код	B	L	CH	Резьба
-----	---	---	----	--------

PF5050-00-01	4	7	8	M5x0.8
PF5050-00-02	5	7	5	G1/8
PF5050-00-04	6.5	9	6	G1/4
PF5050-00-06	7.5	10.5	8	G3/8
PF5050-00-08	10	12.5	10	G1/2

PF5060-00-02	8.5	10	14	G1/8
PF5060-00-04	11	12.5	17	G1/4
PF5060-00-06	12	13.5	20	G3/8
PF5060-00-08	14	16	24	G1/2
PF5060-00-12	18	20	32	G3/4
PF5060-00-16	21	24	36	G1

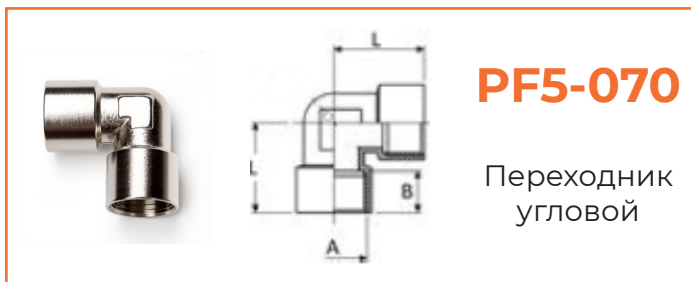

**PF5-070**

Переходник  
угловой

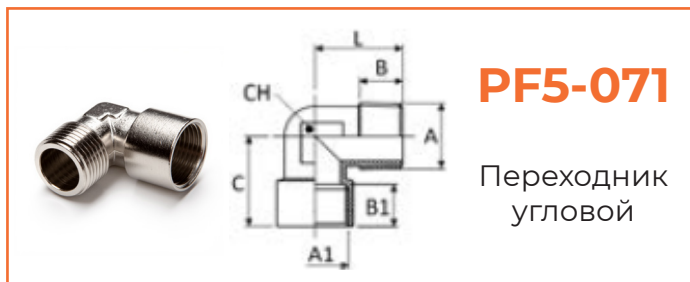

**PF5-071**

Переходник  
угловой

Код	B	L	Резьба
-----	---	---	--------

Код	B	B1	C	L	CH	Резьба A	Резьба A1
-----	---	----	---	---	----	-------------	--------------

PF5070-00-01	5.5	12	M5x0.8
PF5070-00-02	8.5	17	G1/8
PF5070-00-04	11	21.5	G1/4
PF5070-00-06	12	24.5	G3/8
PF5070-00-08	15	31.5	G1/2

PF5071-00-01	4	5.5	12	11	8	M5x0.8	M5x0.8
PF5071-00-02	5.5	8.5	18	15	9	G1/8	R1/8
PF5071-00-04	11	11	23	21.5	13	G1/4	R1/4
PF5071-00-06	11	12	24.8	29	15	G3/8	R3/8
PF5071-00-08	14	14	30	28	30	G1/2	R1/2

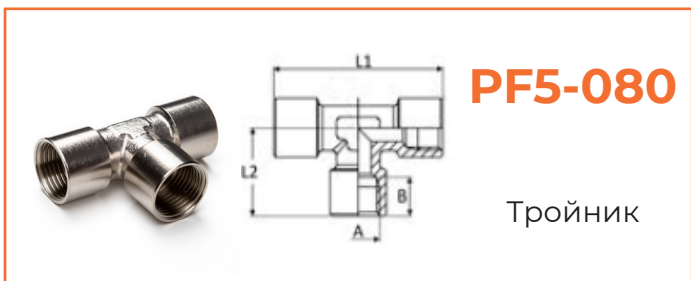

**PF5-080**

Тройник

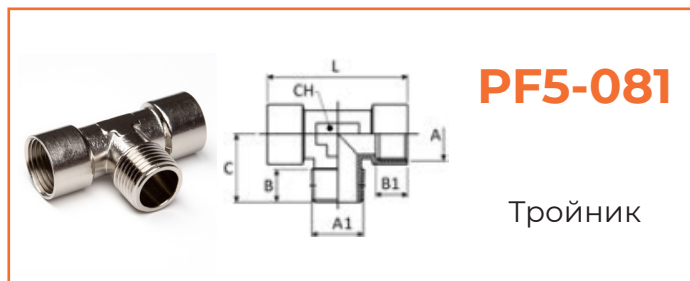

**PF5-081**

Тройник

Код	B	L1	L2	Резьба
-----	---	----	----	--------

Код	B	B1	C	L	CH	Резьба A	Резьба A1
-----	---	----	---	---	----	-------------	--------------

PF5080-00-01	5.5	24	12	M5x0.8
PF5080-00-02	8.5	34	17	G1/8
PF5080-00-04	11	43	21.5	G1/4
PF5080-00-06	12	49	24.5	G3/8
PF5080-00-08	15	63	31.5	G1/2

PF5081-00-01	4	5.5	11	24	8	M5x0.8	M5x0.8
PF5081-00-02	5.5	8.5	15	36	9	G1/8	R1/8
PF5081-00-04	11	14	22	46	13	G1/4	R1/4
PF5081-00-06	7.5	11	21	49	15	G3/8	R3/8
PF5081-00-08	11	14	28	58	18.5	G1/2	R1/2



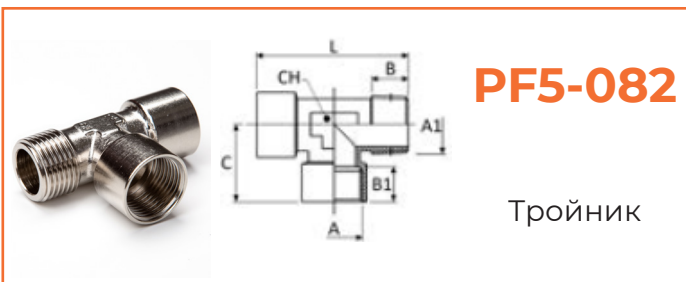

**PF5-082**

Тройник

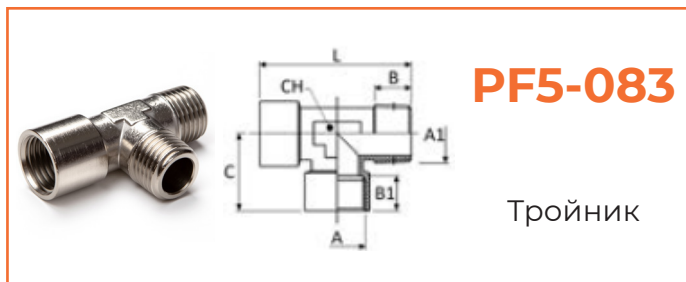

**PF5-083**

Тройник

Код	B	B1	C	L	CH	Резьба A	Резьба A1
-----	---	----	---	---	----	-------------	--------------

Код	B	B1	C	L	CH	Резьба A	Резьба A1
-----	---	----	---	---	----	-------------	--------------

PF5082-00-01	4	5.5	12	24	8	M5x0.8	M5x0.8
PF5082-00-02	5.5	8.5	18	36	9	G1/8	R1/8
PF5082-00-04	11	11	23	45	13	G1/4	R1/4
PF5082-00-06	11	12	24.8	53.8	15	G3/8	R3/8
PF5082-00-08	14	14	30	58	30	G1/2	R1/2

PF5083-00-01	5.5	4	11	23	8	M5x0.8	M5x0.8
PF5083-00-02	8.5	7.5	14.5	32.5	14.5	G1/8	R1/8
PF5083-00-04	11	11	23	45	23	G1/4	R1/4
PF5083-00-06	8.5	7.5	21	46	15	G3/8	R3/8
PF5083-00-08	14	10.5	28	58	19	G1/2	R1/2



**PF5-084**

Тройник

Код	L	L1	L2	Резьба
-----	---	----	----	--------

PF5084-00-01	22	4	11	M5x0.8
PF5084-00-02	30	5.5	15	R1/8
PF5084-00-04	37.5	9.5	19	R1/4
PF5084-00-06	42	7.5	21	R3/8
PF5084-00-08	56	10.5	28	R1/2

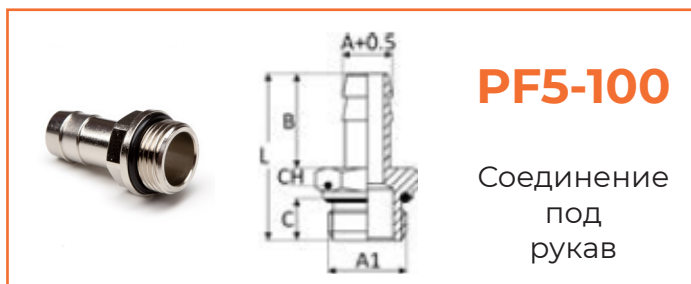

**PF5-100**

Соединение под рукав

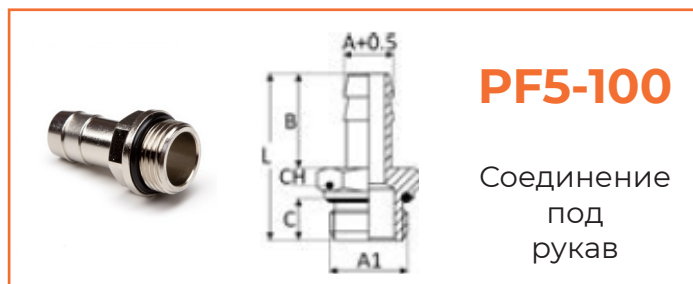

**PF5-100**

Соединение под рукав

Код	C	B	L	CH	A	Резьба
PF5100-05-01	4	18	26	8	5	M5x0.8
PF5100-07-02	5.5	16	25.5	12	7	G1/8
PF5100-07-04	6.5	16	29	14	7	G1/4
PF5100-08-02	5.5	17	26.5	12	8	G1/8
PF5100-08-04	6.5	19	30	17	8	G1/4
PF5100-09-02	5.5	20	29.5	12	9	G1/8
PF5100-09-04	6.5	18	31	14	9	G1/4

Код	C	B	L	CH	A	Резьба
PF5100-09-06	7.5	18	32.5	16	9	G3/8
PF5100-12-04	6.5	20	33	14	12	G1/4
PF5100-12-06	7.5	20	34.5	16	12	G3/8
PF5100-12-08	10	20	37	20	12	G1/2
PF5100-17-06	7.5	26	38.5	20	17	G3/8
PF5100-17-08	10	26	43	20	17	G1/2

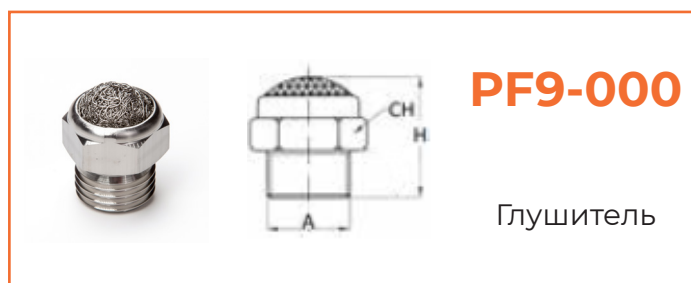

**PF9-000**

Глушитель

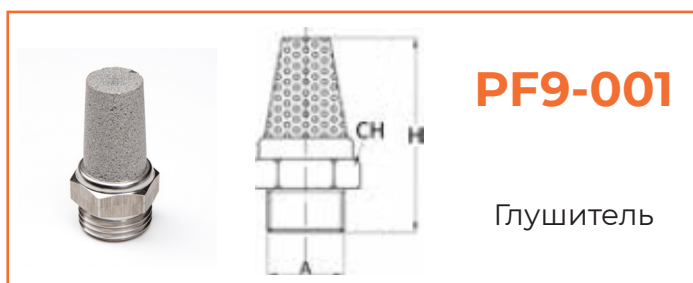

**PF9-001**

Глушитель

Код	H	CH	Резьба
PF9000-00-02	13	12	G1/8
PF9000-00-04	17	17	G1/4
PF9000-00-06	19	19	G3/8
PF9000-00-08	20	20	G1/2
PF9000-00-12	22	22	G3/4
PF9000-00-16	25	25	G1

Код	H	CH	Резьба
PF9001-00-01	26	12	M5x0.8
PF9001-00-02	25	12	G1/8
PF9001-00-04	34	17	G1/4
PF9001-00-06	44	19	G3/8
PF9001-00-08	45	22	G1/2
PF9001-00-12	55	27	G3/4
PF9001-00-16	68	34	G1

# ПНЕВМАТИЧЕСКАЯ ТРУБКА

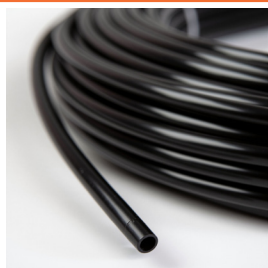

## EE1935

Трубка  
полиамид



## 5552

Трубка  
полиуретан

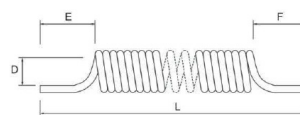

Код	R изгиба	WP	BP	Диаметр
-----	-------------	----	----	---------

EE1935-25-04	20мм.	4.0МПа	11МПа	4/2мм.
EE1935-25-05	25мм.	3.0МПа	9МПа	5/3мм.
EE1935-25-06	37мм.	2.4МПа	7.2МПа	6/4мм.
EE1935-25-08	48мм.	2.0МПа	5.2МПа	8/6мм.
EE1935-25-10	62мм.	1.5МПа	4.4МПа	10/8мм.
EE1935-25-12	67мм.	2.0МПа	5.2МПа	12/9мм.

Код	D	Макс. длина	E (мм.)	F (мм.)
-----	---	----------------	------------	------------

5552-01-02	40	20	80	80
5552-01-03	48	20	80	80
5552-01-04	58	20	80	80

## ПРЕОБРАЗОВАНИЕ ЕДИНИЦ ПОТОКА

	m <sup>3</sup> /s	l/s	cm <sup>3</sup> /s	m <sup>3</sup> /h	m <sup>3</sup> /min	l/h	l/min	ft <sup>3</sup> /min
m <sup>3</sup> /s	1	10 <sup>3</sup>	10 <sup>6</sup>	3600	60	3.6·10 <sup>6</sup>	60·10 <sup>3</sup>	2.1188·10 <sup>3</sup>
l/s	10 <sup>-3</sup>	1	10 <sup>3</sup>	3.6	60·10 <sup>-3</sup>	3.6·10 <sup>3</sup>	60	21188
cm <sup>3</sup> /s	10 <sup>-6</sup>	10 <sup>-3</sup>	1	3600·10 <sup>-6</sup>	60·10 <sup>-6</sup>	3.6	60·10 <sup>-3</sup>	2.1188·10 <sup>-3</sup>
m <sup>3</sup> /h	0.277778·10 <sup>-3</sup>	0.277778	0.277778·10 <sup>3</sup>	1	16.667·10 <sup>-3</sup>	10 <sup>3</sup>	16.667	0.58856
m <sup>3</sup> /min	16.667·10 <sup>-3</sup>	16.667	16.667·10 <sup>3</sup>	60	1	6·10 <sup>4</sup>	10 <sup>3</sup>	35.313
l/h	0.277778·10 <sup>-6</sup>	0.277778·10 <sup>-3</sup>	0.277778	10 <sup>-3</sup>	16.667·10 <sup>-6</sup>	1	16.667·10 <sup>-3</sup>	0.58856·10 <sup>-3</sup>
l/min	16.667·10 <sup>-6</sup>	16.667·10 <sup>-3</sup>	16.667·10 <sup>-6</sup>	60·10 <sup>-3</sup>	10 <sup>-3</sup>	60 <sup>-3</sup>	1	35.313·10 <sup>-3</sup>
ft <sup>3</sup> /min	0.47195·10 <sup>-3</sup>	0.47195	0.47195·10 <sup>3</sup>	1.6990	28.317·10 <sup>-3</sup>	1.6990·10 <sup>3</sup>	28.317	1

**РЕКОМЕНДУЕМЫЙ ПОТОК [л/мин].** (Ø2..Ø12 мм - падение давления 0.3% на метр;  
Ø15.. Ø40 мм - падение давления 0.3% на метр).

	Ø2	Ø4	Ø6	Ø8	Ø10	Ø12	Ø15	Ø20	Ø25	Ø32	Ø40
2 bar	3.5	19	53	110	190	300	370	750	1350	2500	4300
4 bar	6.2	35	97	200	350	550	700	1400	2400	4500	7800
6 bar	9	50	140	290	500	800	1000	2000	3500	6500	11500
8 bar	11.8	66	185	380	660	1050	1300	2600	4500	8500	15000
10 bar	14.5	82	230	470	820	1300	1600	3250	5700	10500	18500

## ПРЕОБРАЗОВАНИЕ ЕДИНИЦ ДАВЛЕНИЯ

	Pa	kPa	mPa	bar	mbar	kp/cm <sup>2</sup>	cm H <sub>2</sub> O	mm H <sub>2</sub> O	mm Hg	p.s.i.
Pa	1	10 <sup>-3</sup>	10 <sup>-5</sup>	10 <sup>-5</sup>	10 <sup>-2</sup>	10.1972·10 <sup>-6</sup>	10.1972·10 <sup>-3</sup>	101.972·10 <sup>-3</sup>	7.50062·10 <sup>-3</sup>	0.145038·10 <sup>-3</sup>
kPa	10 <sup>-3</sup>	1	10 <sup>-3</sup>	10 <sup>-2</sup>	10	10.1972·10 <sup>-3</sup>	10.1972	101.972	7.50062	0.145038
mPa	10 <sup>-6</sup>	10 <sup>3</sup>	1	10	10 <sup>4</sup>	10.1972	10.1972·10 <sup>3</sup>	101.972·10 <sup>3</sup>	7.50062·10 <sup>3</sup>	0.145038·10 <sup>3</sup>
bar	10 <sup>5</sup>	10 <sup>2</sup>	10 <sup>-1</sup>	1	10 <sup>3</sup>	1.01972	1.01972·10 <sup>3</sup>	10.1972·10 <sup>3</sup>	750.062	14.5038
mbar	100	0.1	10 <sup>-4</sup>	10 <sup>-3</sup>	1	1.01972·10 <sup>-3</sup>	1.01972	10.1972	0.750062	14.5038·10 <sup>-3</sup>
kp/cm <sup>2</sup>	198066.5	98.0665	98.0665·10 <sup>-3</sup>	0.98995	980.665	1	10 <sup>3</sup>	10 <sup>-4</sup>	735.559	14.2233
cm H <sub>2</sub> O	98.0665	98.0665·10 <sup>-3</sup>	98.0665·10 <sup>-6</sup>	0.98665·10 <sup>-3</sup>	0.98665	10 <sup>-3</sup>	1	10	0.735559	14.2233·10 <sup>-3</sup>
mm H <sub>2</sub> O	9.80665	9.80665·10 <sup>-3</sup>	9.80665·10 <sup>-6</sup>	9.80665·10 <sup>-6</sup>	9.80665·10 <sup>-3</sup>	10 <sup>-4</sup>	10 <sup>-1</sup>	1	73.5559·10 <sup>-3</sup>	14.2233·10 <sup>-4</sup>
mm Hg	133.322	133.322·10 <sup>-3</sup>	133.322·10 <sup>-6</sup>	1.33322·10 <sup>-3</sup>	1.33322	1.35951·10 <sup>-3</sup>	1.35951	13.5951	1	19.3368·10 <sup>-3</sup>
p.s.i.	6894.76	6.89476	6.89476·10 <sup>-3</sup>	68.9476·10 <sup>-3</sup>	68.9476	70.307·10 <sup>-3</sup>	70.307	703.07	51.7149	1

Код	Стр	Код	Стр	Код	Стр	Код	Стр	Код	Стр
PF2010-04-01	3	PF2030-08-06	4	PF2090-06-04	5	PF2150-04-04	7	PF3030-05-05	8
PF2010-04-02	3	PF2030-10-08	4	PF2090-06-05	5	PF2150-05-02	7	PF3030-06-06	8
PF2010-04-04	3	PF2030-12-10	4	PF2090-06-08	5	PF2150-06-02	7	PF3030-08-08	8
PF2010-06-01	3	PF2040-04-04	4	PF2090-08-04	5	PF2150-06-04	7	PF3030-10-10	8
PF2010-06-02	3	PF2040-05-05	4	PF2090-08-05	5	PF2150-08-02	7	PF3030-12-12	8
PF2010-06-04	3	PF2040-06-06	4	PF2090-08-06	5	PF2150-08-04	7	PF3030-15-15	8
PF2010-06-M12	3	PF2040-08-08	4	PF2090-10-06	5	PF2150-08-06	7	PF3050-04-04	8
PF2010-07-04	3	PF2040-10-10	4	PF2090-10-08	5	PF2150-10-04	7	PF3050-05-05	8
PF2010-08-02	3	PF2040-12-12	4	PF2090-12-04	6	PF2150-10-06	7	PF3050-06-06	8
PF2010-08-04	3	PF2040-14-14	4	PF2090-12-06	6	PF2150-12-04	7	PF3050-08-08	8
PF2010-08-06	3	PF2050-04-04	5	PF2090-12-08	6	PF2150-12-06	7	PF3050-10-10	8
PF2010-08-M12	3	PF2050-05-05	5	PF2090-12-10	6	PF2150-12-08	7	PF3050-12-12	8
PF2010-09-06	3	PF2050-06-06	5	PF2090-14-10	6	PF2150-14-08	7	PF3050-15-15	8
PF2010-10-04	3	PF2050-08-08	5	PF2090-14-12	6	PF2160-04-01	7	PF3112-05-02	9
PF2010-10-06	3	PF2050-10-10	5	PF2110-04-01	6	PF2160-04-02	7	PF3112-06-02	9
PF2010-10-08	3	PF2050-12-12	5	PF2110-04-02	6	PF2160-06-02	7	PF3112-06-04	9
PF2010-12-04	3	PF2050-14-14	5	PF2110-04-04	6	PF2160-06-04	7	PF3112-08-02	9
PF2010-12-06	3	PF2070-04-01	5	PF2110-05-01	6	PF2160-08-02	7	PF3112-08-04	9
PF2010-12-08	3	PF2070-04-02	5	PF2110-05-02	6	PF2160-08-04	7	PF3112-08-06	9
PF2010-13-08	3	PF2070-04-04	5	PF2110-05-04	6	PF2160-08-06	7	PF3112-10-04	9
PF2010-14-06	3	PF2070-05-01	5	PF2110-06-01	6	PF2160-10-04	7	PF3112-10-06	9
PF2010-14-08	3	PF2070-05-02	5	PF2110-06-02	6	PF2160-10-06	7	PF3112-10-08	9
PF2020-04-02	4	PF2070-05-04	5	PF2110-06-04	6	PF2160-12-04	7	PF3112-12-06	9
PF2020-04-04	4	PF2070-06-01	5	PF2110-08-02	6	PF2160-12-06	7	PF3112-12-08	9
PF2020-06-02	4	PF2070-06-02	5	PF2110-08-04	6	PF2160-12-08	7	PF3112-15-08	9
PF2020-06-04	4	PF2070-06-04	5	PF2110-08-06	6	PF3011-04-02	8	PV65-0000-02-02	9
PF2020-08-02	4	PF2070-06-M12	5	PF2110-10-04	6	PF3011-05-02	8	PV65-0000-04-04	9
PF2020-08-04	4	PF2070-08-02	5	PF2110-10-06	6	PF3011-06-02	8	PV65-0000-06-06	9
PF2020-10-04	4	PF2070-08-04	5	PF2110-10-08	6	PF3011-06-04	8	PV65-0000-08-08	9
PF2020-10-06	4	PF2070-08-06	5	PF2110-12-04	6	PF3011-08-02	8	PF0030-04-04	10
PF2030-04-04	4	PF2070-08-M12	5	PF2110-12-06	6	PF3011-08-04	8	PF0030-06-04	10
PF2030-06-06	4	PF2070-10-04	5	PF2110-12-08	6	PF3011-08-06	8	PF0030-06-06	10
PF2030-07-07	4	PF2070-10-06	5	PF2110-14-06	6	PF3011-10-02	8	PF0030-08-06	10
PF2030-08-08	4	PF2070-12-04	5	PF2110-14-08	6	PF3011-10-04	8	PF0030-08-08	10
PF2030-09-09	4	PF2070-12-06	5	PF2130-04-04	6	PF3011-10-06	8	PF0030-10-06	10
PF2030-10-10	4	PF2070-12-08	5	PF2130-06-06	6	PF3011-10-08	8	PF0030-10-08	10
PF2030-12-12	4	PF2070-14-06	5	PF2130-08-08	6	PF3011-12-06	8	PF0030-10-10	10
PF2030-13-13	4	PF2070-14-08	5	PF2130-10-10	6	PF3011-12-08	8	PF0030-12-08	10
PF2030-14-14	4	PF2090-04-06	5	PF2130-12-12	6	PF3011-15-08	8	PF0030-12-10	10
PF2030-06-04	4	PF2090-05-04	5	PF2150-04-02	7	PF3030-04-04	8	PF0030-12-12	10

Код	Стр	Код	Стр	Код	Стр	Код	Стр	Код	Стр
PF0030-14-14	10	PF5010-08-12	13	PF5041-02-04	15	PF5082-00-06	17	EE1935-25-08	20
PF0030-16-16	10	PF5010-12-12	13	PF5041-04-04	15	PF5082-00-08	17	EE1935-25-10	20
PF0040-04-04	11	PF5010-12-16	13	PF5041-04-06	15	PF5083-00-01	17	EE1935-25-12	20
PF0040-06-06	11	PF5010-16-16	13	PF5041-06-06	15	PF5083-00-02	17	5552-01-02	20
PF0040-08-08	11	PF5011-02-02	14	PF5041-06-08	15	PF5083-00-04	17	5552-01-03	20
PF0040-10-10	11	PF5011-02-04	14	PF5041-08-08	15	PF5083-00-06	17	5552-01-04	20
PF0040-12-12	11	PF5011-02-06	14	PF5041-08-12	15	PF5083-00-08	17		
PF0050-04-04	11	PF5011-04-04	14	PF5050-00-01	15	PF5084-00-01	17		
PF0050-06-06	11	PF5011-04-06	14	PF5050-00-02	15	PF5084-00-02	17		
PF0050-08-08	11	PF5011-04-08	14	PF5050-00-04	15	PF5084-00-04	17		
PF0050-10-10	11	PF5011-06-06	14	PF5050-00-06	15	PF5084-00-06	17		
PF0050-12-12	11	PF5011-06-08	14	PF5050-00-08	15	PF5084-00-08	17		
PF0060-04-04	11	PF5011-08-08	14	PF5060-00-02	15	PF5100-05-01	18		
PF0060-06-06	11	PF5011-08-12	14	PF5060-00-04	15	PF5100-07-02	18		
PF0060-08-08	11	PF5011-12-12	14	PF5060-00-06	15	PF5100-07-04	18		
PF0060-10-10	11	PF5011-12-16	14	PF5060-00-08	15	PF5100-08-02	18		
PF0060-12-12	11	PF5011-16-16	14	PF5060-00-12	15	PF5100-09-02	18		
PF0101-00-04	11	PF5020-01-01	14	PF5060-00-16	15	PF5100-09-04	18		
PF0101-00-06	11	PF5020-02-02	14	PF5070-00-02	16	PF5100-09-06	18		
PF0101-00-08	11	PF5020-04-04	14	PF5070-00-04	16	PF5100-12-04	18		
PF0101-00-10	11	PF5020-06-06	14	PF5070-00-06	16	PF5100-12-06	18		
PF0101-00-12	11	PF5020-08-08	14	PF5070-00-08	16	PF5100-12-08	18		
PV5300-03-04-04	12	PF5020-12-12	14	PF5071-00-01	16	PF5100-17-06	18		
PV5300-03-06-06	12	PF5020-16-16	14	PF5071-00-02	16	PF5100-17-08	18		
PV5300-03-08-08	12	PF5030-02-01	14	PF5071-00-04	16	PF9000-00-02	18		
PV5300-03-10-10	12	PF5030-04-02	14	PF5071-00-06	16	PF9000-00-04	18		
PV5500-02-04-04	12	PF5030-06-02	14	PF5071-00-08	16	PF9000-00-06	18		
PV5500-02-06-06	12	PF5030-06-04	14	PF5080-00-01	16	PF9000-00-08	18		
PV5500-02-08-08	12	PF5030-08-04	14	PF5080-00-02	16	PF9000-00-12	18		
PV5500-02-10-10	12	PF5030-08-06	14	PF5080-00-04	16	PF9000-00-16	18		
PF5010-01-02	13	PF5030-12-08	14	PF5080-00-06	16	PF9001-00-01	18		
PF5010-02-02	13	PF5031-04-02	15	PF5080-00-08	16	PF9001-00-02	18		
PF5010-02-04	13	PF5031-06-02	15	PF5081-00-01	16	PF9001-00-04	18		
PF5010-02-06	13	PF5031-06-04	15	PF5081-00-02	16	PF9001-00-06	18		
PF5010-04-04	13	PF5031-08-02	15	PF5081-00-04	16	PF9001-00-08	18		
PF5010-04-06	13	PF5031-08-04	15	PF5081-00-06	16	PF9001-00-12	18		
PF5010-04-08	13	PF5031-08-06	15	PF5081-00-08	16	PF9001-00-16	18		
PF5010-06-06	13	PF5031-12-08	15	PF5082-00-01	17	EE1935-25-04	20		
PF5010-06-08	13	PF5031-16-08	15	PF5082-00-02	17	EE1935-25-05	20		
PF5010-08-08	13	PF5041-02-02	15	PF5082-00-04	17	EE1935-25-06	20		



Великий Новгород  
Владивосток  
Владимир  
Воронеж  
Выборг  
Гатчина  
Екатеринбург  
Казань  
Кемерово  
Кингисепп

Краснодар  
Красноярск  
Липецк  
Москва  
Мурманск  
Нижний Новгород  
Новокузнецк  
Новороссийск  
Новосибирск  
Омск

Пермь  
Прокопьевск  
Ростов-на-Дону  
Санкт-Петербург  
Таганрог  
Тюмень  
Уфа  
Хабаровск  
Ярославль



8 (800) 222-66-80



info@hydrocas.ru



www.hydrocas.ru